

Since 1994

KELSONS[®]

When You Think Foundry...Think KELSONS

Grow your
BUSINESS
with our
FOUNDRY
Equipments



PRODUCTS RANGE FOR

- ▶ Sand Plant & Allied Equipments
- ▶ Ladle & Metal Handling Equipments
- ▶ Core Shooters & Allied Equipments
- ▶ Shot Blasting & Fetting
- ▶ Testing - Sand & Metal

Auto Mould Handling

Pouring System



Vibro Knock Out

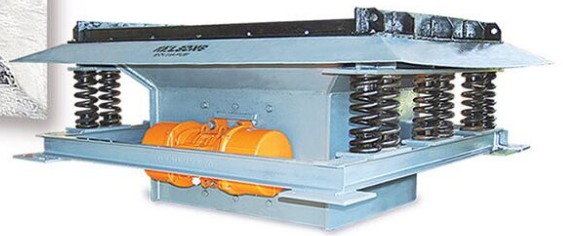

Bucket Elevator,
Polygonal Siever
with Cooler



Vibro Knock Out-Top

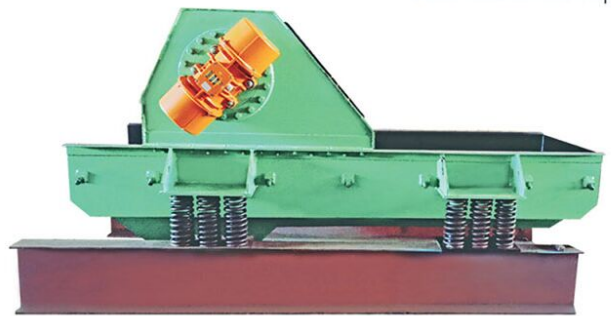

Vibro Feeder



Vibro Sand Cooler



Polygonal Siver



Tumblast

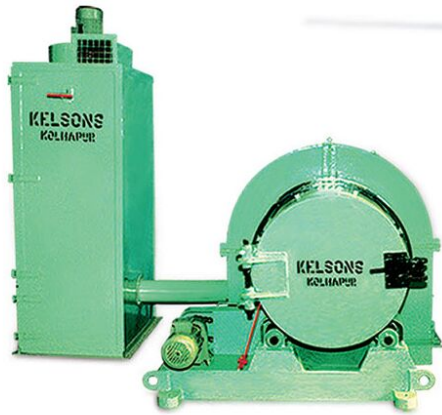

Swing Frame Grinder
16"-18"- 20"- 22"



Pedestal Grinder
with Dust
Collection System



Core Painting Unit-
Bath & Dip Type.



Rotary Sand Drier
LPG & Diesel



Core Oven



CAPACITIES

300, 500, 600,
750 & 1000 kg



SALIENT FEATURES

- ▶ Sturdy construction
- ▶ Easy for preventive & routine maintenance
- ▶ Inside lining-stainless steel / Ceramic Lining
- ▶ All pulleys are taper lock pulleys
- ▶ Guide vanes for pushing the sand in spin action below the rotors
- ▶ Rotor blades fine, Angular & carbide tips brazed
- ▶ Homogenous sand mixing - Excellent sand quality - Uniform sand strength
- ▶ High casting quality
- ▶ Environmentally friendly operation with no dust leakage or loss of fines
- ▶ Fully automatic control panel
- ▶ Auto water - Dozing panel.



◀ Intensive Mixer with Ceramic Lining



TECHNICAL DATA

| TYPE | KIM-1900-150 | KIM-750 -100 | KIM-600-75 | KIM-500-40 | KIM-300-20 |
|---|-------------------|-------------------|-------------------|-------------------|------------|
| Dimensions in mm | | | | | |
| A Diameter | 1900 | 1900 | 1600 | 1600 | 1300 |
| B Height of Mixer | 4200 | 4065 | 3870 | 3730 | 2425 |
| Batch Specifications | | | | | |
| Batch Capacity (Max.) | 1000 Kg | 750 Kg | 600 Kg | 500 Kg | 300 Kg |
| Cycle time | 90 -120 S | 90 -120 S | 90 -120 S | 90 -120 S | 90 -120 S |
| Batch/Hour | 36 | 36 | 36 | 36 | 30 |
| Mixing Rate | 30 T/h | 22.5 T/h | 21 T/h | 18 T/h | 9 T/h |
| Vessel Cap. Used+New Sand | 1.0M ³ | 1.0M ³ | 0.7M ³ | 0.7M ³ | --- |
| Mixing Power | | | | | |
| Drive Power (HP) | 150 | 100 | 75 | 40 | 20 |
| Blenders Power | | | | | |
| Drive Power (HP)/ Number | 30+30/2 | 20+20/2 | 30/1 | 20/1 | 7.5/1 |
| Total Weight : Approx | 12000 Kg | 10500 Kg | 7000 Kg | 5500 Kg | 2500 Kg |
| Optional Accessories | | | | | |
| Ceramic Lining, Mechanical Charger, Load Cell System & Control Panel. | | | | | |

Sand Plant & Allied Equipments : Knock Out Machine, Punch Out, Auto Mould Handling, Belt Conveyor, OBMS, Bucket Elevator, Polygonal Siever, Sand Cooler, Moulding Boxes, Pallet Cars, Transfer Trolley, Pouring Monorail, Intensive Mixer, Sand Muller, Sand Aerator, Skip Charger, Sand Siever, Pin Lift Moulding M/c & Pneumatic Moulding M/c. **Core Shooters & Allied Equipments :** Core Sand Mixer, Sand Drier, Cold Box Core Shooter, Core Painting Unit, Core Oven, Liquid Resin Sand Coating Plant, Shell Core Shooter, Shell Moulding M/c, Shell Mould Fuser, Shell Core Blower.

Ladle & Metal Handling Equipments : Hand Shank Ladle, Lip Pouring Ladle, Tea Spout Pouring Ladle, Bottom Pouring Ladle, Drum Type Ladle, SG Treatment Ladle, Auto Pour Ladle, Cupola (Divided Blast) Cupola Charger.

Shot Blasting & Fettingling : Shot Blast Machine, Grinder & Apron Conveyor. **Testing :** Sand & Metal Testing

KELSONS ENGINEERS & FABRICATORS

Plot No. E-22, MIDC, Shiroli, Kolhapur - 416 122 Maharashtra. (INDIA) Tel : +91 230 2460156 Fax : +91 230 2460543

E-mail : sale@kelsongroup.com / mktg.kelsongroup@gmail.com Web : www.kelsongroup.com

Pneumatic Jolt Squeeze Moulding Machine

Since 1994 **KELSONS**[®]

When You Think Foundry...Think KELSONS

More than
150 Machines
are Installed &
Succesfully
Working
in India



SALIENT FEATURES

- ▶ Sturdy Construction
- ▶ Easy to Operate
- ▶ High Production & Low Maintenance
- ▶ Parts of S. G. Iron & FG - 260 Grade

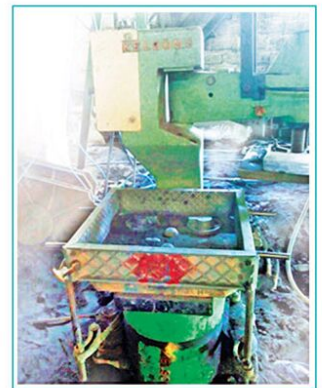

Leading Manufacturers & Exporters of : Full Range of Foundry Machines,
Foundry Sand Testing Equipment, Foundry Metal Testing Equipment & Supplying Resin Coating Sand

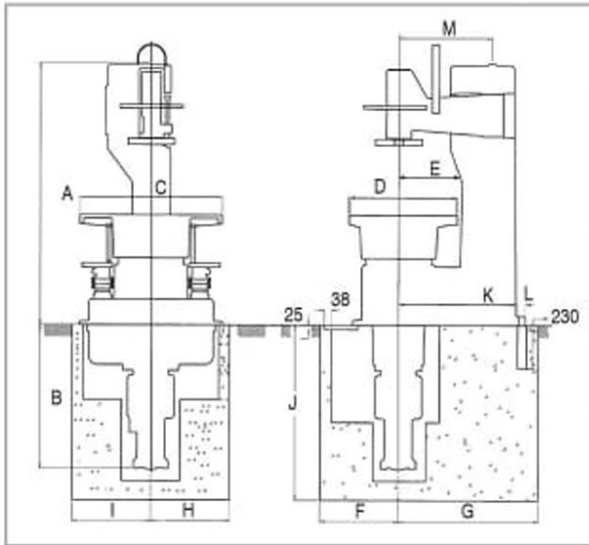

Moulding Boxes with Assembly

OVER ALL DIMENSIONS (mm) IN KPL RANGE

| TYPE | A | B | C | D | E | F | G | H | I | J | K | L | M |
|-------|------|-----|-----|-----|-----|-----|------|-----|-----|------|-----|----|-----|
| KPL-2 | 1425 | 780 | 755 | 540 | 360 | 510 | 790 | 455 | 455 | 960 | 660 | 50 | 510 |
| KPL-3 | 1790 | 950 | 975 | 640 | 375 | 640 | 1020 | 610 | 610 | 1200 | 780 | 90 | 590 |

| TECHNICAL DATA | KPL - 2 | KPL - 3 |
|---|-------------------------|-----------------------|
| Jolt Capacity # Kgs | 280 | 350 |
| Squeeze Force # Kgs | 5000 | 7200 |
| Pattern Drawn mm (In) | 205 (8") | 260 (10") |
| Table Sizes mm (In) | 750 X 535 (29.5" x 21") | 966 x 635 (38" x 25") |
| Max. Size of Mould box Used mm (In) (ID) | 508 X 508 (20" x 20") | 610 x 710 (24" x 28") |
| Min. Size of Mould Box Used mm (In) (ID) | 406 X 406 (16" x 16") | 530 x 406 (21" x 16") |
| Max. Height of Table to Sq- Plate mm (In) | 390 (15") | 510 (20") |
| Squeeze Plate adjustment mm (In) | 203 (8") | 200 (8") |
| Squeeze Stroke (mm) | 76 (3") | 100 (4") |
| Table Height From Floor (mm) | 600 (23 1/2") | 635 (25") |
| Free Air Capacity Per Cycle m3 | 0.35 | 0.41 |

NOTE *These are outside dimension of moulding box # At 6.3 kg /cm² air pressure (Kgs) # All above given Dimensions are approximate.

Sand Plant & Allied Equipments : Knock Out Machine, Punch Out, Auto Mould Handling, Belt Conveyor, OBMS, Bucket Elevator, Polygonal Siever, Sand Cooler, Moulding Boxes, Pallet Cars, Transfer Trolley, Pouring Monorail, Intensive Mixer, Sand Muller, Sand Aerator, Skip Charger, Sand Siever, Pin Lift Moulding M/c & Pneumatic Moulding M/c. **Core Shooters & Allied Equipments** : Core Sand Mixer, Sand Drier, Cold Box Core Shooter, Core Painting Unit, Core Oven, Liquid Resin Sand Coating Plant, Shell Core Shooter, Shell Moulding M/c, Shell Mould Fuser, Shell Core Blower. **Ladle & Metal Handling Equipments** : Hand Shank Ladle, Lip Pouring Ladle, Tea Spout Pouring Ladle, Bottom Pouring Ladle, Drum Type Ladle, SG Treatment Ladle, Auto Pour Ladle, Cupola (Divided Blast) Cupola Charger. **Shot Blasting & Fettingling** : Shot Blast Machine, Grinder & Apron Conveyor. **Testing** : Sand & Metal Testing

KELSONS ENGINEERS & FABRICATORS

Plot No. E-22, MIDC, Shirol, Kolhapur - 416 122 Maharashtra. (INDIA) Tel : +91 230 2460156 Fax : +91 230 2460543

E-mail : sale@kelsonsgroup.com / mktg.kelsons@gmail.com Web : www.kelsonsgroup.com

Cold Box Core Shooter

Since 1994 **KELSONS**[®]

When You Think Foundry...Think KELSONS

CAPACITIES

3, 7, 10, 15, 20,
30, 50, 80 & 100 kg

MODEL - Pneumatic/Hydraulic

1. Horizontal Parting
2. Vertical Parting
3. Universal Model

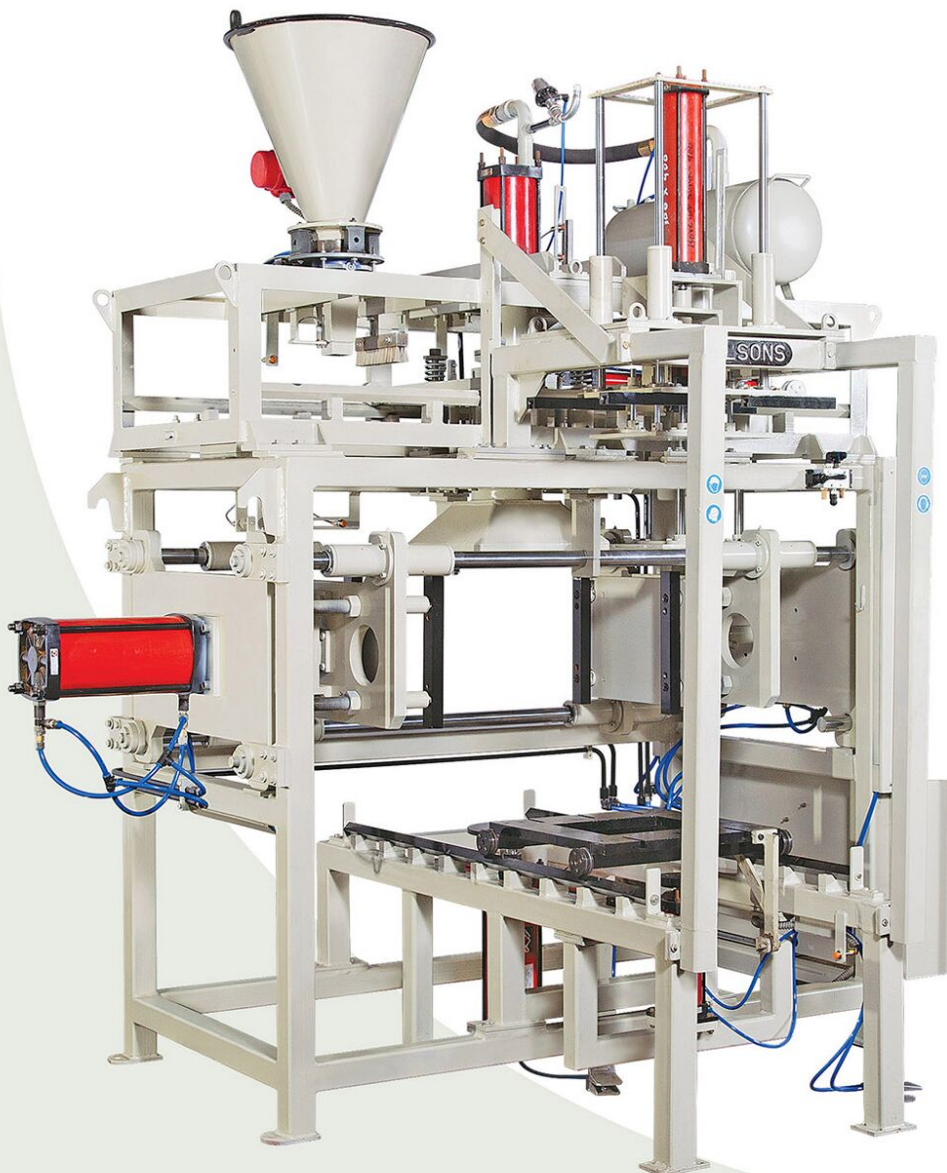

All Cold Box Core Shooter Are As Per Standards Sizes & Other Customised Also Available
Leading Manufacturers & Exporters Of : Full Range Of Foundry Machines, Sand Testing Equipment & Metal Testing Equipment.

SALIENT FEATURES

- ▶ Compact and Robust Design
- ▶ High dimensional accuracy
- ▶ PLC Control / MMI
- ▶ Efficient Shooting System
- ▶ H / V and Multi-Part Core Boxes
- ▶ Short Cycle Time with high productivity
- ▶ Air Drier Unit

Compact Model
7 & 10 kg
-100 Machines
are Installed &
Successfully
Working
in India



TECHNICAL DATA

| MODEL | KCBCS-3 | KCBCS-FA-7 | KCBCS-FA-10 | KCBCS-FA-15 | KCBCS-FA-20 | KCBCS-FA-30 | KCBCS-FA-50 | KCBCS-FA-80 | KCBCS-FA-100 |
|---|---|------------|-------------|-------------|-------------|-------------|-------------|-------------|--------------|
| Type | Vertical / Horizontal Particle (Universal System) | | | | | | | | |
| Shoot Capacity | 3 kg | 7 kg | 10 kg | 15 kg | 20 kg | 30 kg | 50 kg | 80 kg | 100 kg |
| Core Retrieval-Type | Manually / Automatic | | | | | | | | |
| CONTROL SYSTEM | | | | | | | | | |
| Operation Type | Automatic / Pneumatic | | | | | | | | |
| Cycle Control Type | Automatic by means of PLC with MMI | | | | | | | | |
| Machine Operation | Pneumatic / Hydraulic | | | | | | | | |
| Machine Dry Cycle Time | Dependes on Machine Capacity | | | | | | | | |
| Electricity/Power Required to Equipment | Volts 415 / Ph 3 / Hz 50 / Kw 4 | | | | | | | | |

Sand Plant & Allied Equipments : Knock Out Machine, Punch Out, Auto Mould Handling, Belt Conveyor, OBMS, Bucket Elevator, Polygonal Siever, Sand Cooler, Moulding Boxes, Pallet Cars, Transfer Trolley, Pouring Monorail, Intensive Mixer, Sand Muller, Sand Areator, Skip Charger, Sand Siever, Pin Lift Moulding M/c & Pneumatic Moulding M/c. **Core Shooters & Allied Equipments :** Core Sand Mixer, Sand Drier, Cold Box Core Shooter, Core Painting Unit, Core Oven, Liquid Resin Sand Coating Plant, Shell Core Shooter, Shell Moulding M/c, Shell Mould Fuser, Shell Core Blower.

Ladle & Metal Handling Equipments : Hand Shank Ladle, Lip Pouring Ladle, Tea Spout Pouring Ladle, Bottom Pouring Ladle, Drum Type Ladle, SG Treatment Ladle, Auto Pour Ladle, Cupola (Divided Blast) Cupola Charger.

Shot Blasting & Fettling : Shot Blast Machine, Grinder & Apron Conveyor. **Testing :** Sand & Metal Testing

KELSONS ENGINEERS & FABRICATORS

Plot No. E-22, MIDC, Shirol, Kolhapur - 416 122 Maharashtra. (INDIA) Tel : +91 230 2460156 Fax : +91 230 2460543

E-mail : sale@kelsonsgroup.com / mktg.kelsons@gmail.com Web : www.kelsonsgroup.com

Rollover Vertical Parting Shooting Machine

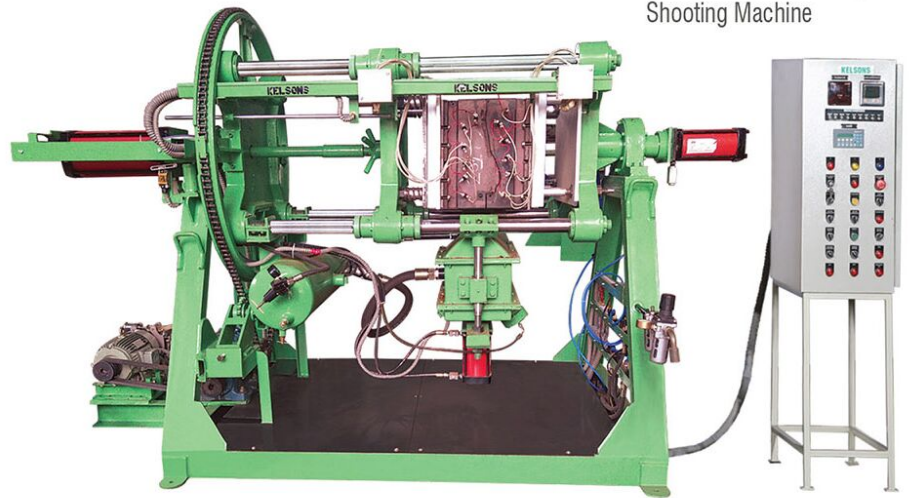

Rollover Vertical Parting Swing Door

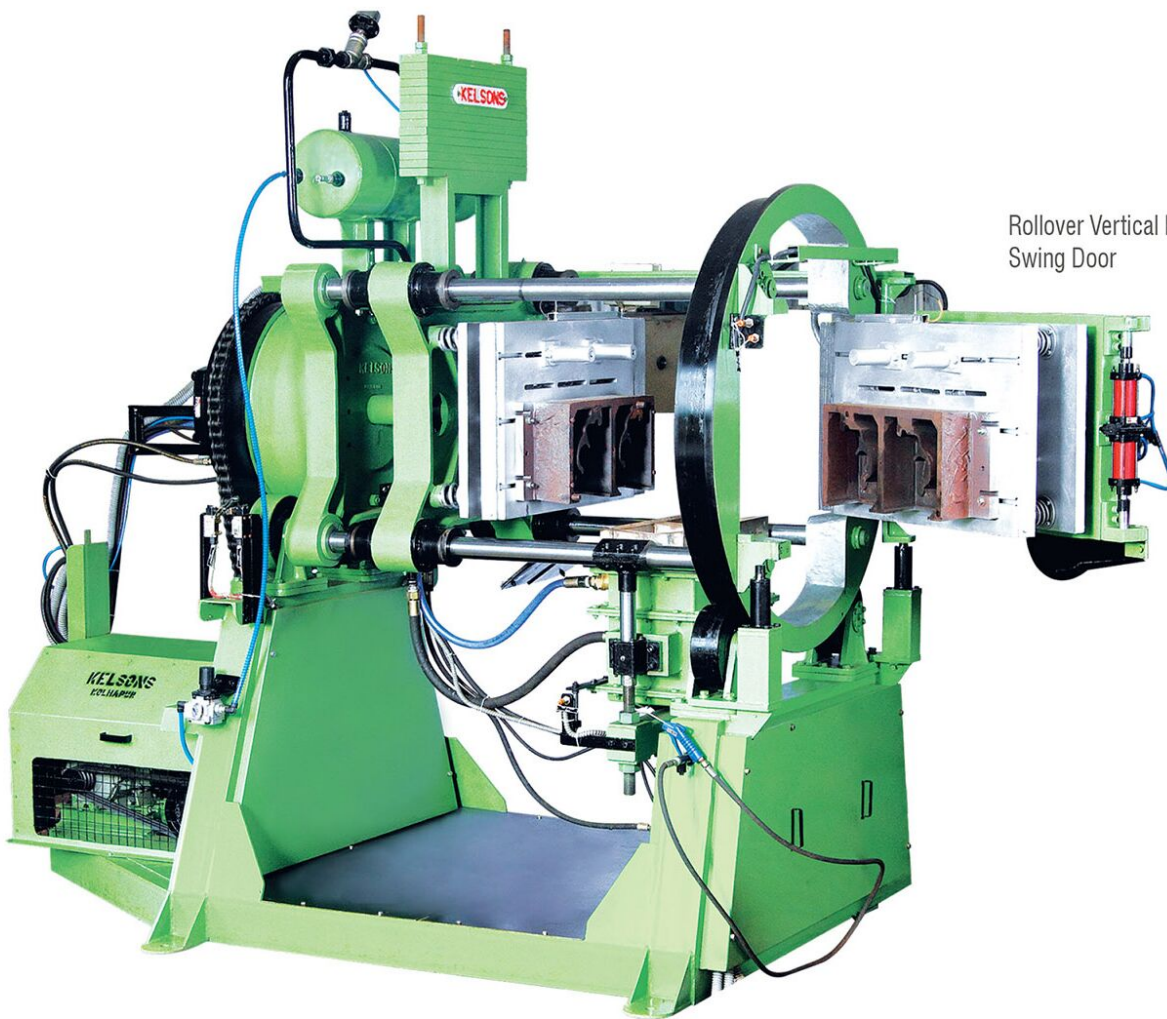

TECHNICAL DATA

| MODEL | HEATER PLATE SIZES | | | |
|--|-------------------------------|-------------------------------|-------------------------------|-----------------------|
| Vertical Parting Top shooting | KCS-FA- VP-300x600 | KCS-FA-VP- 400x400 | KCS-FA- VP-400x600 | KCS-FA- VP-500x600 |
| Horizontal Parting Top Shooting | KCS-FA- HP-400x400 | KCS-FA-HP- 400x600 | KCS-FA- HP -500x600 | KCS-FA- HP-600x600 |
| Rollover Vertical Parting Shooting | KCS-FA- RO-VP-300x400 | KCS-FA-RO- VP-400x600 | KCS-FA- RO-VP-600x600 | KCS-FA- RO-VP-500x700 |
| Rollover - Vertical Parting - Swing Door | KCS-FA- RO-VP-SD-500x700 | KCS-FA-RO- VP-SD-600x900 | | |
| Vertical Parting - Top & Bottom Shooting- Rollover - Swing Door | KCS-FA- VP-TSBS-RO-SD-450x450 | KCS-FA- VP-TSBS-RO-SD-550x550 | KCS-FA- VP-TSBS-RO-SD-600x600 | |

TYPES OF SHELL CORE SHOOTER

Fully Automatic Machines

1. Vertical Parting Top Shooting
2. Vertical Parting Top Shooting - Core Tilting Trolley Type
3. Horizontal Parting Top Shooting
4. Rollover Vertical Parting Shooting
5. Rollover - Vertical Parting - Swing Door
6. Vertical Parting - Top and Bottom Shooting- Rollover - Swing Door

Vertical Parting - Top and Bottom
Shooting - Rollover - Swing Door

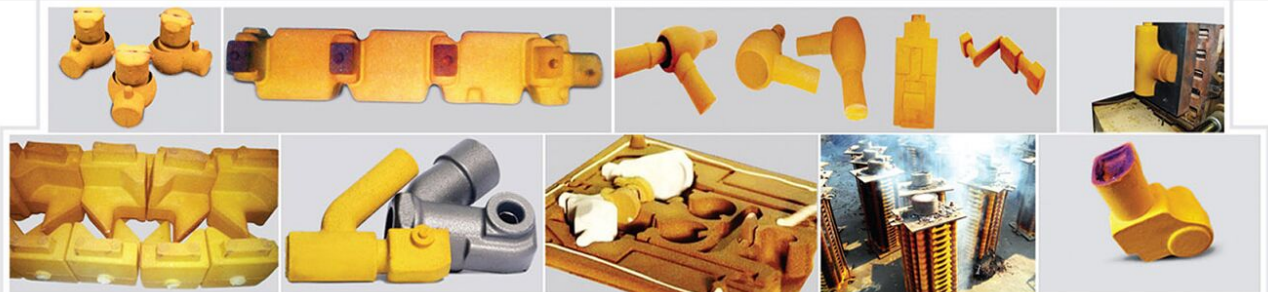
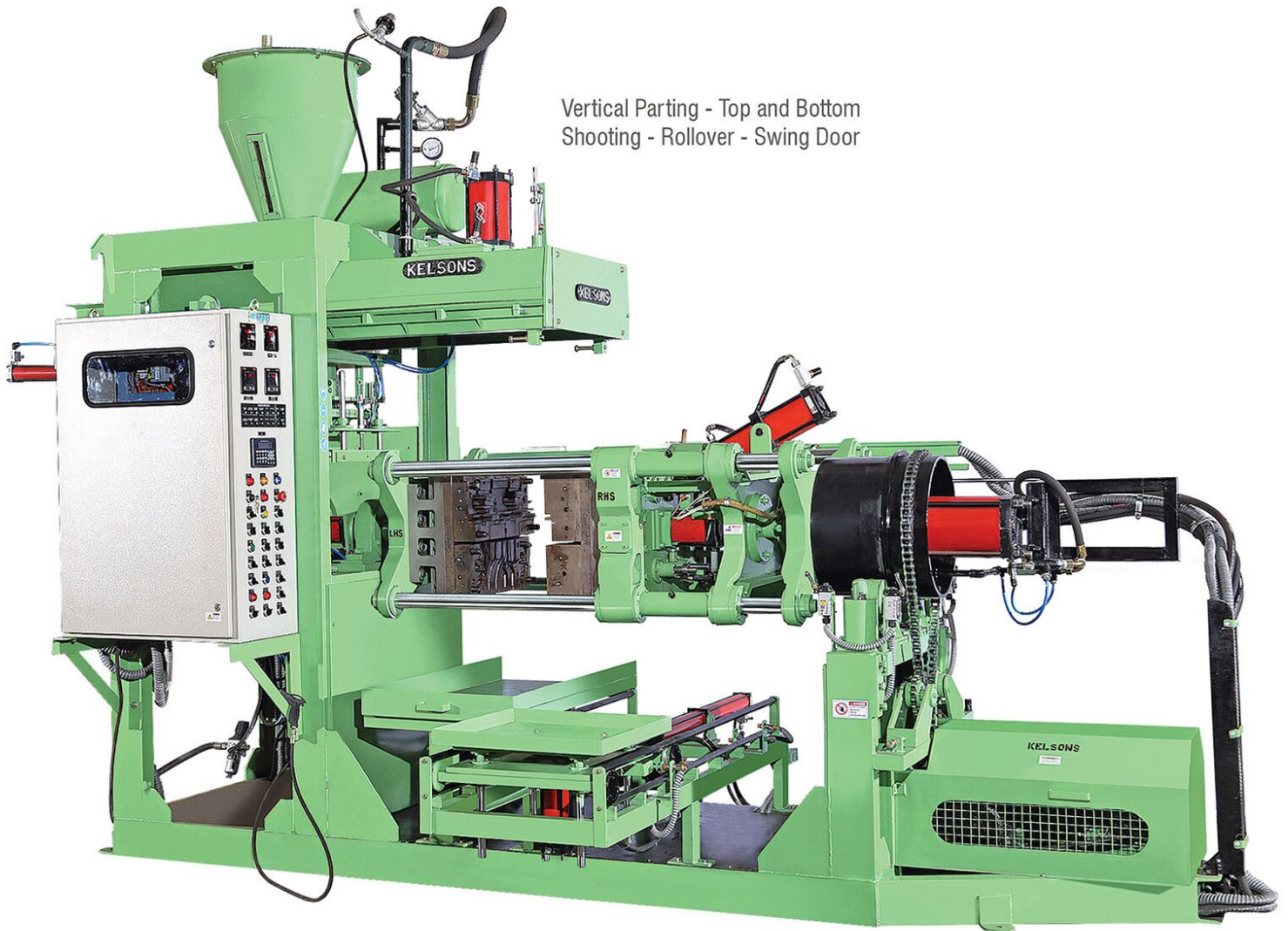

All Shell Core Shooter & Shell Moulding are as Per Standard Sizes & Other Customised Also Available
Leading Manufacturers & Exporters Of : Full Range Of Foundry Machines, Sand Testing Equipment & Metal Testing Equipment.

SALIENT FEATURES

- ▶ High process reliability & Environmental sustainability.
- ▶ Robust Design, High Dimensional Accuracy.
- ▶ Flexible, Good Productivity & Quality Machines
- ▶ Facility of auto repeat cycle operation.
- ▶ Vertical/Horizontal & Multi part core box capability.
- ▶ Auto/Manual mode selection facility.
- ▶ Heavy-duty bars for core box carriage plates.
- ▶ Safety interlocks incorporated in the control system.
- ▶ All movements by means of pneumatic cylinders.
- ▶ PLC control, MMI Interface, Efficient shooting system.

Vertical Parting Top Shooting
Core Tilting Trolley Type



Vertical Parting
Top Shooting



Horizontal Parting
Top Shooting



RESIN COATING PLANT

CAPACITIES

75 kg, 150 kg, &
300 kg



PRODUCT RANGE

SAND PLANT & ALLIED EQUIPMENTS

Knock Out Machine, Punch Out,
Auto Mould Handling,
Belt Conveyor, OBMS,
Bucket Elevator,
Polygonal Siever, Sand Cooler,
Hopper, Moulding Boxes,
Pallet Cars, Transfer Trolley,
Pouring Monorail Structure,
Intensive Mixer, Sand Muller,
Sand Aerator, Skip Charger,
Sand Siever, Pin Lift Moulding M/c
Pneumatic Moulding M/c.

CORE SHOOTERS & ALLIED EQUIPMENTS

Core Sand Mixer, Sand Drier,
Cold Box Core Shooter,
Core Painting Unit, Core Oven,
Liquid Resin Sand Coating Plant,
Shell Core Shooter,
Shell Moulding M/c,
Shell Mould Fuser,
Shell Core Blower.

LADLE & METAL HANDLING EQUIPMENTS

Hand Shank Ladle,
Lip Pouring Ladle,
Tea Spout Pouring Ladle,
Bottom Pouring Ladle,
Drum Type Ladle,
SG Treatment Ladle,
Auto Pour Ladle,
Cupola (Divided Blast)
Cupola Charger.

SHOT BLASTING & FETTLING

Shot Blast Machine,
Grinder & Apron Conveyor.

TESTING - SAND & METAL

SHELL FUSER



SHELL MOULDING

MODELS

KSM-FA-16x16, KSM-FA-20x20
KSM-FA-20x22, KSM-FA-20x24

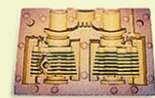

Leading Manufacturers & Exporters of
Full Range of Foundry Equipment, Sand Testing Equipment & Metal Testing Equipment.

KELSONS ENGINEERS & FABRICATORS

Plot No. E-22, MIDC, Shirol, Kolhapur - 416 122 Maharashtra. (INDIA) Tel : +91 230 2460156 Fax : +91 230 2460543

E-mail : sale@kelsonsgroup.com / mktg.kelsons@gmail.com Web : www.kelsonsgroup.com

Leading Manufacturer & Exporter's of Ladle

**LARGE
CAPACITY
LADLES
UPTO 25 Mt.**



Lip Pouring
Ladle



SG Treatment
Ladle



Bottom Pouring
Ladle

More Than 1500 Ladles are Working Satisfactorily in India and Abrod

All Ladles are as per IS Standards & Customised ladle
Leading Manufacturers & Exporters of : Full Range of Foundry Machines, Foundry Sand Testing Equipment,
Foundry Metal Testing Equipment & Supplying Resin Coating Sand

LADLE FEATURES

- ▶ Manufacturers of Ladles-100 kg to 25 Ton.
- ▶ All Kelsons Ladles are as per IS Standard.
- ▶ Raw materials are Ultra Tested.
- ▶ There is no direct load on bolts.



Ladle Preheater
(250 kg to 15 mt)
Petrol & Diesel



Lip Pouring Ladle
300 kg to 25 Mt



Tea Spout Ladle
150 Kg To 2 Mt



Filter Type Ladle
100 Kg To 4 Mt



SG Treatment Ladle
150 Kg To 5 Mt



SG Treatment Ladle Filter Type
300 Kg To 5 Mt



Bottom Pouring Ladle
500 Kg To 20 Mt



Auto Pour Ladle

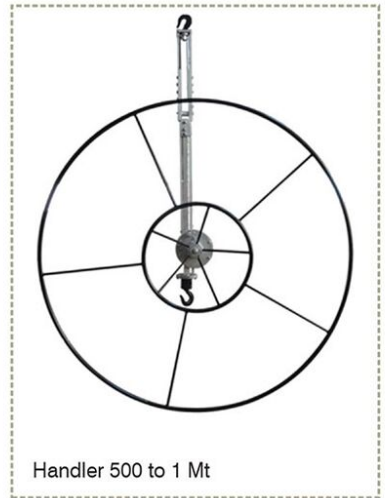

Handler 500 to 1 Mt

Sand Plant & Allied Equipments : Knock Out Machine, Punch Out, Auto Mould Handling, Belt Conveyor, OBMS, Bucket Elevator, Polygonal Siever, Sand Cooler, Moulding Boxes, Pallet Cars, Transfer Trolley, Pouring Monorail, Intensive Mixer, Sand Muller, Sand Aerator, Skip Charger, Sand Siever, Pin Lift Moulding M/c & Pneumatic Moulding M/c. **Core Shooters & Allied Equipments :** Core Sand Mixer, Sand Drier, Cold Box Core Shooter, Core Painting Unit, Core Oven, Liquid Resin Sand Coating Plant, Shell Core Shooter, Shell Moulding M/c, Shell Mould Fuser, Shell Core Blower.

Ladle & Metal Handling Equipments : Hand Shank Ladle, Lip Pouring Ladle, Tea Spout Pouring Ladle, Bottom Pouring Ladle, Drum Type Ladle, SG Treatment Ladle, Auto Pour Ladle, Cupola (Divided Blast) Cupola Charger.

Shot Blasting & Fettling : Shot Blast Machine, Grinder & Apron Conveyor. **Testing :** Sand & Metal Testing

KELSONS ENGINEERS & FABRICATORS

Plot No. E-22, MIDC, Shirol, Kolhapur - 416 122 Maharashtra. (INDIA) Tel : +91 230 2460156 Fax : +91 230 2460543

E-mail : sale@kelsonsgroup.com / mktg.kelsons@gmail.com Web : www.kelsonsgroup.com

Shot Blast Machine

Since 1994 **KELSONS**[®]

When You Think Foundry...Think KELSONS

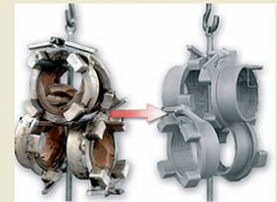
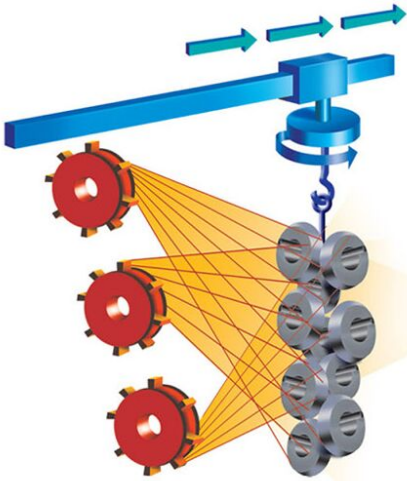

KSBM - FA - 500 kg

Leading Manufacturers & Exporters of : Full Range of Foundry Machines,
Foundry Sand Testing Equipment, Foundry Metal Testing Equipment & Supplying Resin Coating Sand

SHOT BLAST MACHINE

Y-TYPE-1T, 2 T & 5 T



Turbine Housing Assembly

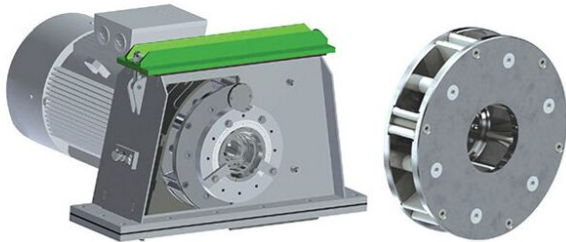

TECHNICAL DATA

| TYPE | KSBM-300 | KSBM-SA-500 | KSBM-FA-500 | KSBM-1000 |
|--|--------------------|--------------------|--------------------|--------------------|
| Load Carrying Capacity in Kgs | 300 | 500 | 500 | 1000 |
| Cabin Size in mm | 1250 x 1350 x 1500 | 1500 x 1500 x 1650 | 1500 x 1500 x 1650 | 1800 x 1800 x 2000 |
| Impeller Wheel | 2 Nos. | 2 Nos. | 2 Nos. | 3 Nos. |
| Impeller Horse Power in HP | 7.5 x 2 | 12.5 x 2 | 15 x 2 | 15 x 3 |
| Maximum length of Parts Can be cleaned in mm | 1000 | 1400 | 1400 | 1600 |
| Diameter of Job Turning Circle in mm | 900 | 1200 | 1200 | 1500 |
| Cycle Time (Minutes) | 5 - 7 | 5 - 7 | 5 - 7 | 8 - 10 |
| Shot flow / Per min in Kg | 380 | 380 | 380 | 380 |
| Total Height of M/C Above Ground Level (A) in mm | 4170 | 5630 | 5615 | 6615 |
| Height of M/C Below Ground Level (B) in mm | 750 | 2210 | 2210 | 2500 |
| Through put Tonnes/ hour | 1.5 to 2 | 2.4 to 3 | 3 to 3.5 | 4.8 to 5.5 |
| Total Horse Power Required (HP) | 23 | 41.5 | 52.50 | 67.5 |
| Magnetic Separators | --- | --- | ✓ | ✓ |
| Manganese Plate | --- | ✓ | ✓ | ✓ |

Optional Accessories : Fully Automatic / Semi Automatic System-Magnetic Separators, Pulse Jet Dust Collector & PLC Control System

MONORAIL CONVEYOR FOR SHOT BLAST MACHINE

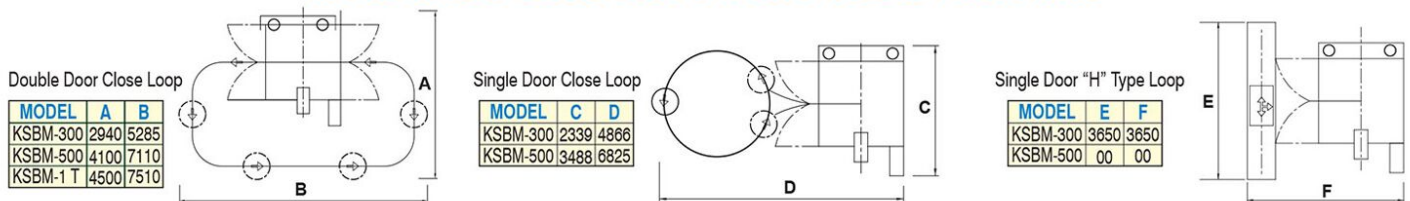

KELSONS ENGINEERS & FABRICATORS

Plot No. E-22, MIDC, Shiroli, Kolhapur - 416 122 Maharashtra. (INDIA) Tel : +91 230 2460156 Fax : +91 230 2460543

E-mail : sale@kelsonsgroup.com / mktg.kelsons@gmail.com Web : www.kelsonsgroup.com

Lumps Breaker - Attrition Type
Up to 2 Ton / Hour



Lumps Breaker - Attrition Type
Up to 10 Ton / Hour



Core Sand Mixer



PRODUCT RANGE

SAND PLANT & ALLIED EQUIPMENTS

Knock Out Machine, Punch Out, Auto Mould Handling, Belt Conveyor, OBMS, Bucket Elevator, Polygonal Siever, Sand Cooler, Hopper, Moulding Boxes, Pallet Cars, Transfer Trolley, Pouring Monorail Structure, Intensive Mixer, Sand Muller, Sand Aerator, Skip Charger, Sand Siever, Pin Lift Moulding M/c, Pneumatic Moulding M/c.

CORE SHOOTERS & ALLIED EQUIPMENTS

Core Sand Mixer, Sand Drier, Cold Box Core Shooter, Core Painting Unit, Core Oven, Liquid Resin Sand Coating Plant, Shell Core Shooter, Shell Moulding M/c, Shell Mould Fuser, Shell Core Blower.

LADLE & METAL HANDLING EQUIPMENTS

Hand Shank Ladle, Lip Pouring Ladle, Tea Spout Pouring Ladle, Bottom Pouring Ladle, Drum Type Ladle, SG Treatment Ladle, Auto Pour Ladle, Cupola (Divided Blast) Cupola Charger.

SHOT BLASTING & FETTLING

Shot Blast Machine, Grinder & Apron Conveyor.

TESTING - SAND & METAL TESTING

Leading Manufacturers & Exporters of
Full Range of Foundry Equipment, Sand Testing Equipment & Metal Testing Equipment.

KELSONS ENGINEERS & FABRICATORS

Plot No. E-22, MIDC, Shirol, Kolhapur - 416 122 Maharashtra. (INDIA) Tel : +91 230 2460156 Fax : +91 230 2460543

E-mail : sale@kelsonsgroup.com / mktg.kelsons@gmail.com Web : www.kelsonsgroup.com